

Sample Boards 2023

LAST UPDATED: 24-07-2023

DEMO

Sample Boards

- 23-001 FFC50 to FFC50 Constantan 3
- 23-002 FFC50 to FFC50 Flex-Rigid Jason 4
- 23-003 Vacuum PCB Design Ruud van Tol 5
- 23-004 4uD25 Female to 2xFFC50 Corentin 6

23-001 FFC50 to FFC50 Constantan

Size (LxWxT): 56 x 47 x 1.5 mm

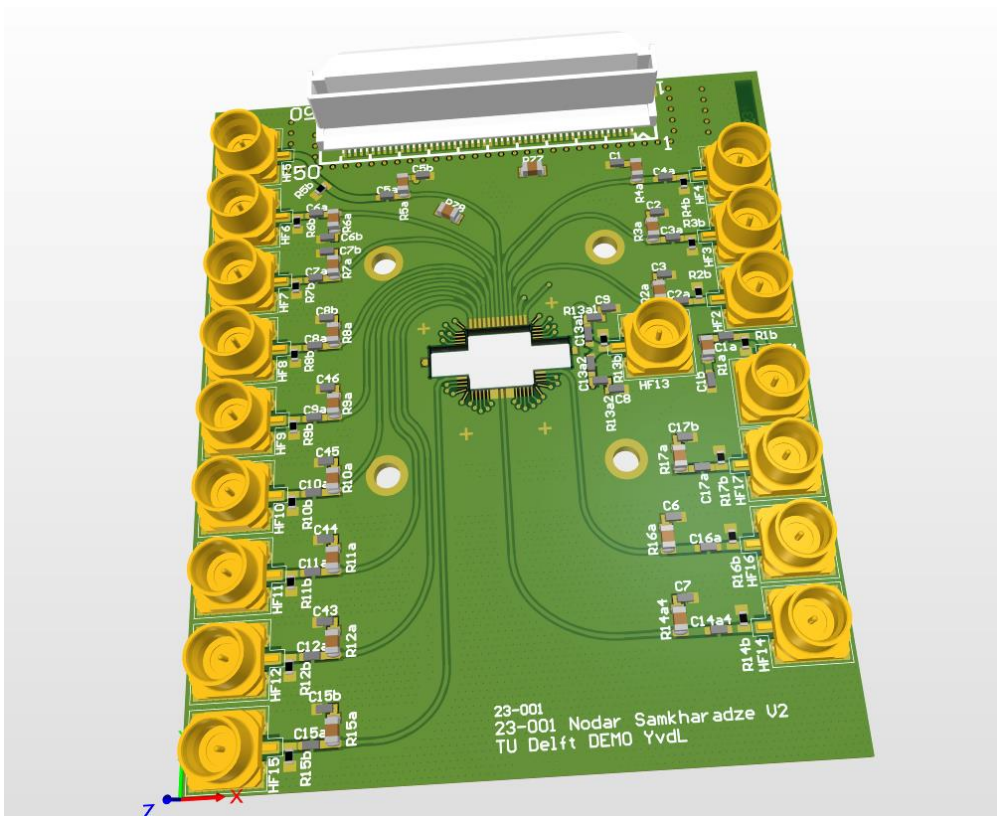
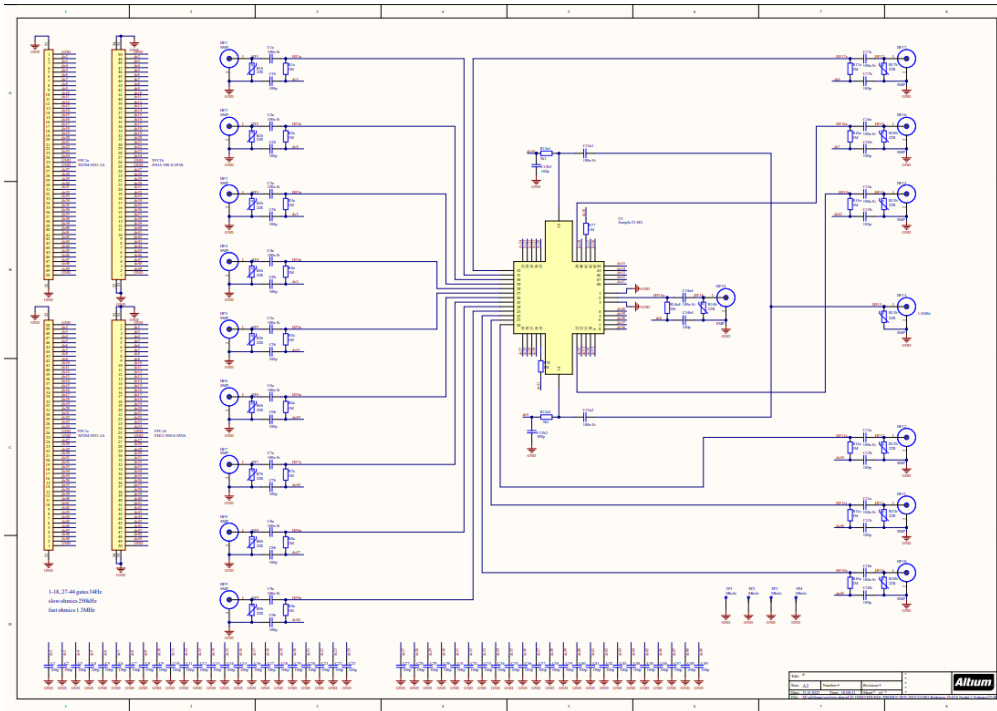

23-002 FFC50 to FFC50 Flex-Rigid Jason

Size (LxWxT): 450 x 245 x 1.5 mm

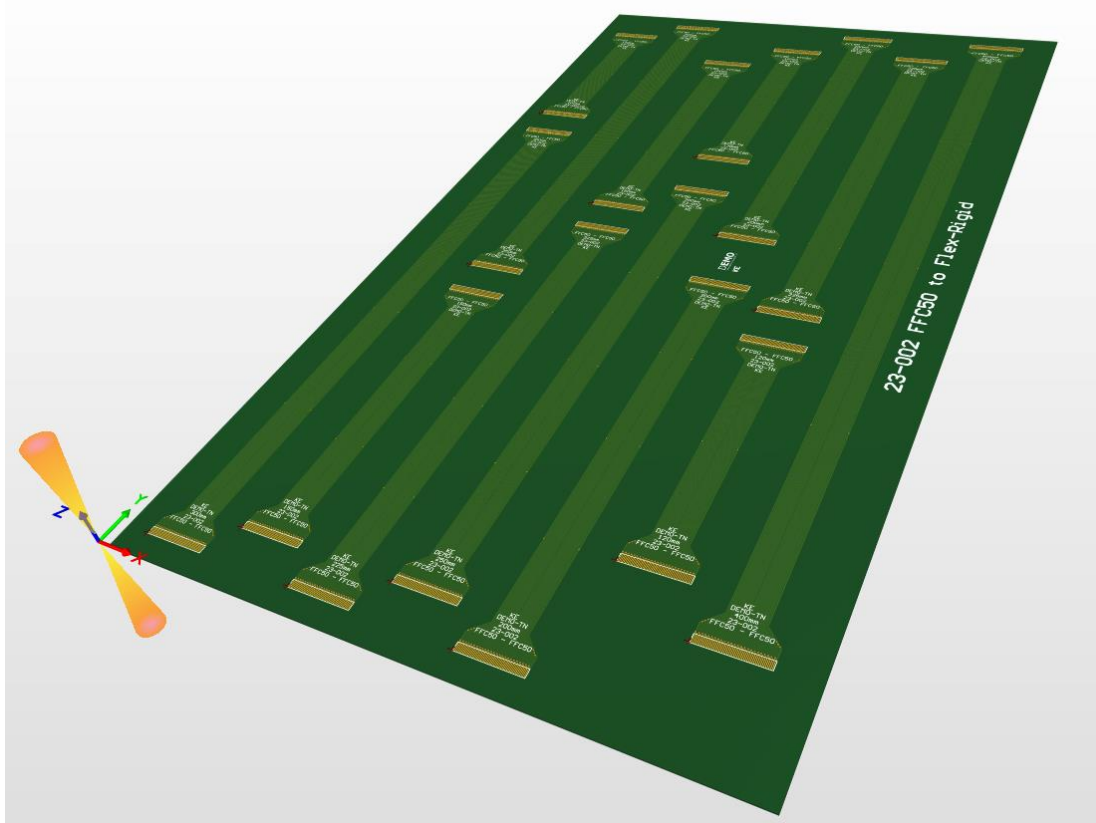
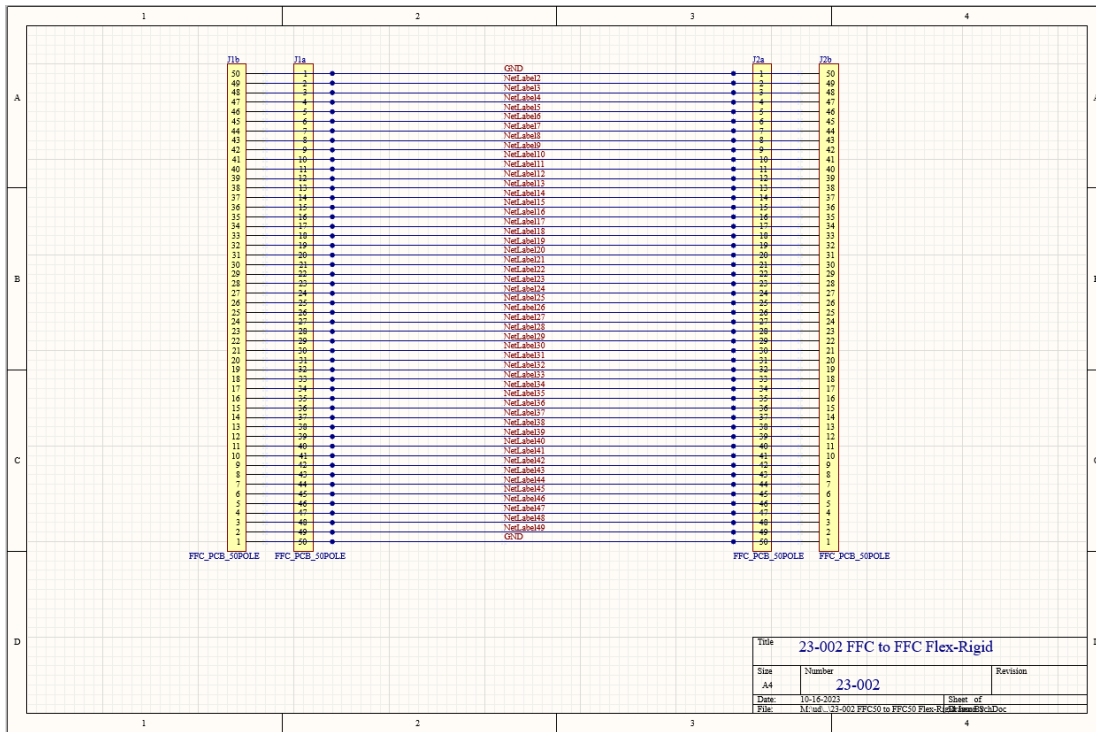

23-003 Vacuum PCB Design Ruud van Tol

Size (LxWxT): 105 x 80 x 1.5 mm

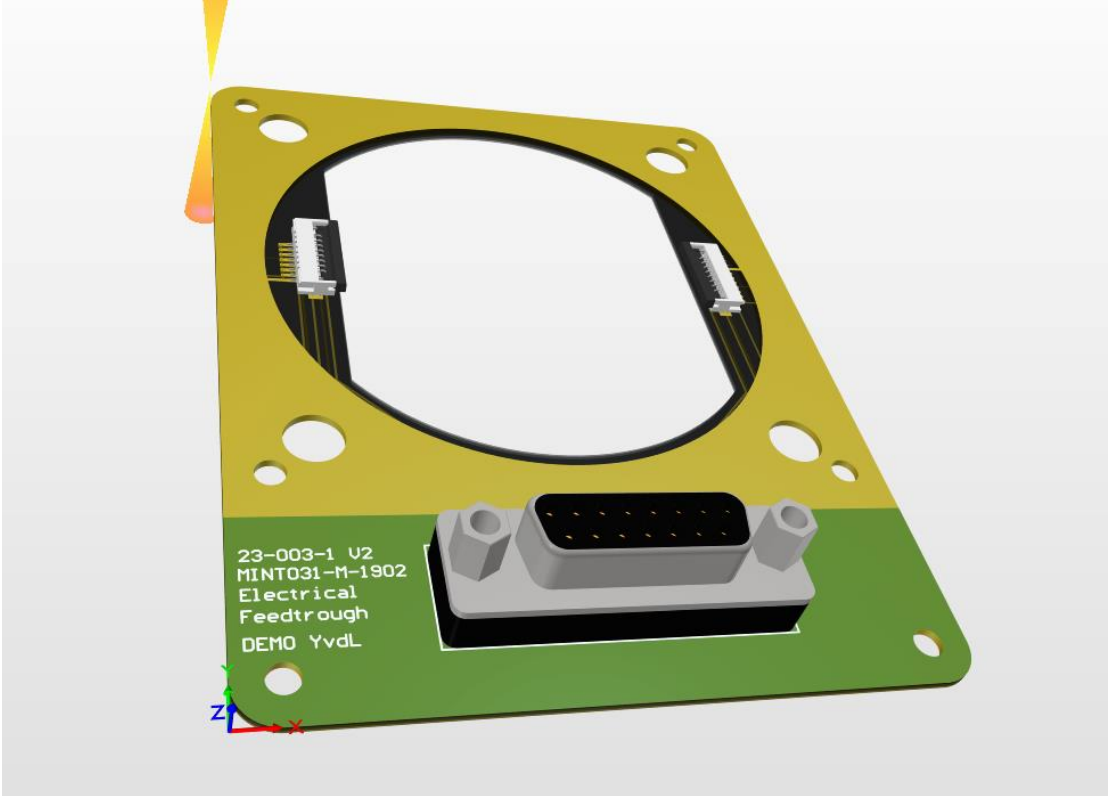
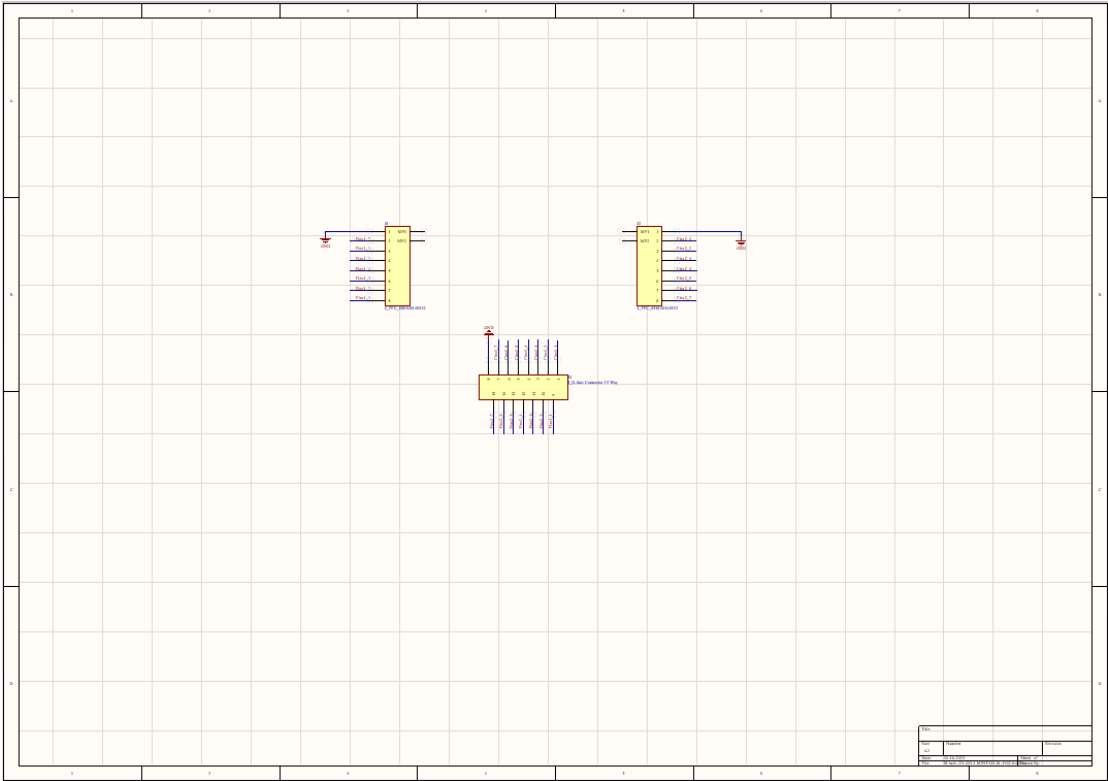

23-004 4uD25 Female to 2xFFC50

Corentin

Size (LxWxT): 70 x 50 x 1.5 mm

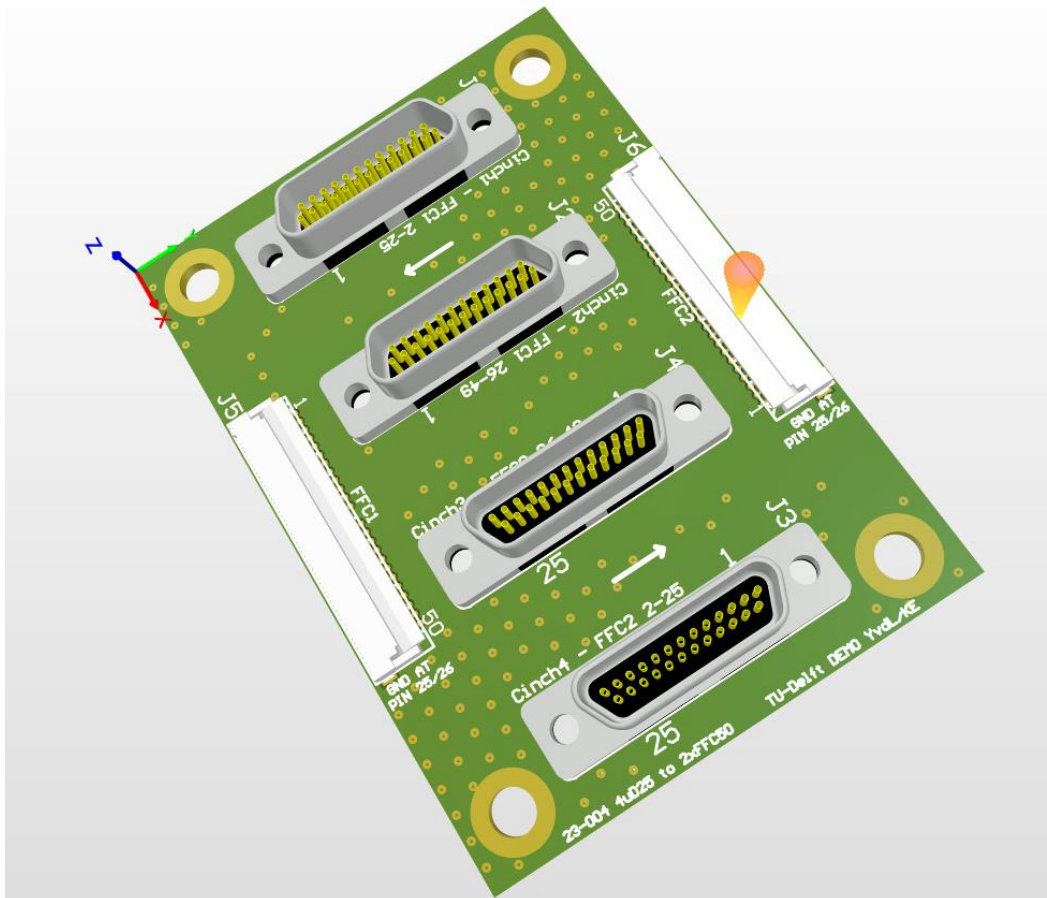
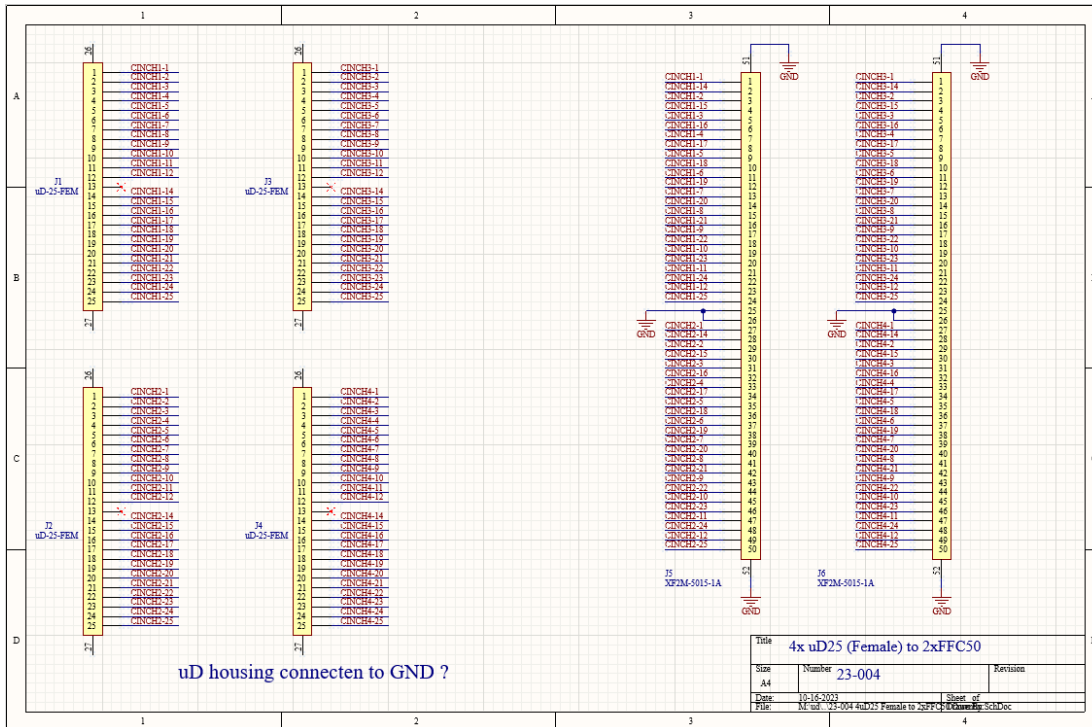

23-005 Sample Board Niccolo Jana

Size (LxWxT) 23-005-1: 28 x 20.5 x 1.5 mm
 23-005-2: 55 x 51 x 1.5 mm
 23-005-3: 55 x 52 x 1.5 mm
 23-005-4: 27 x 20.5 x 1.5 mm

